

Presentation and Performance

Loudspeaker System
Design Reference Guide

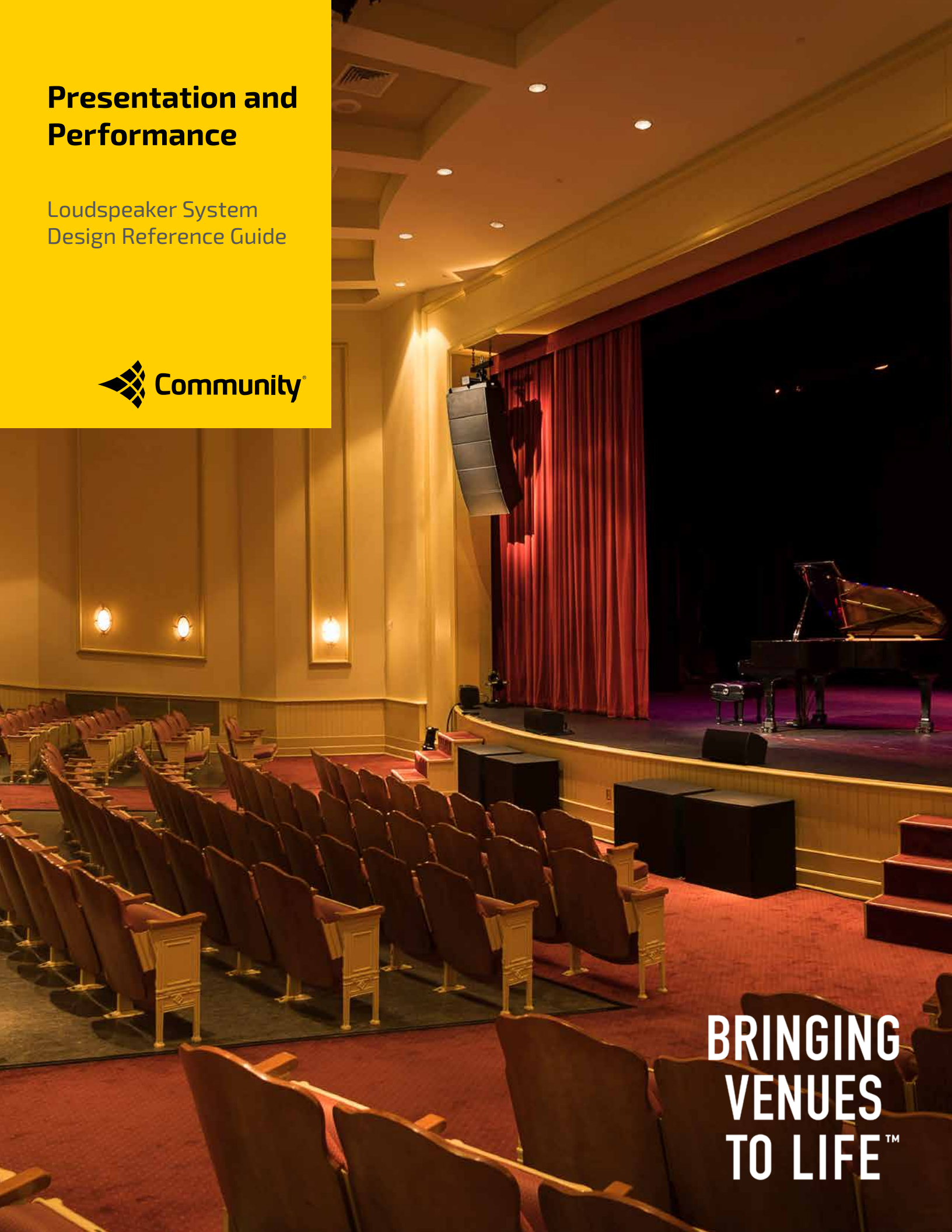

**BRINGING
VENUES
TO LIFE™**



There are many sizes, styles and types of performance and presentation spaces. This Design Guide suggests coverage options for some typical educational, meeting room and performance applications.

Whether it's a school play, music concert, multimedia conference presentation, or a group performance at a local club, Community strives to assist you in providing the best sound possible. For additional information, please refer to our website and/or contact our TAG Team (Technical Applications Group).



Contents

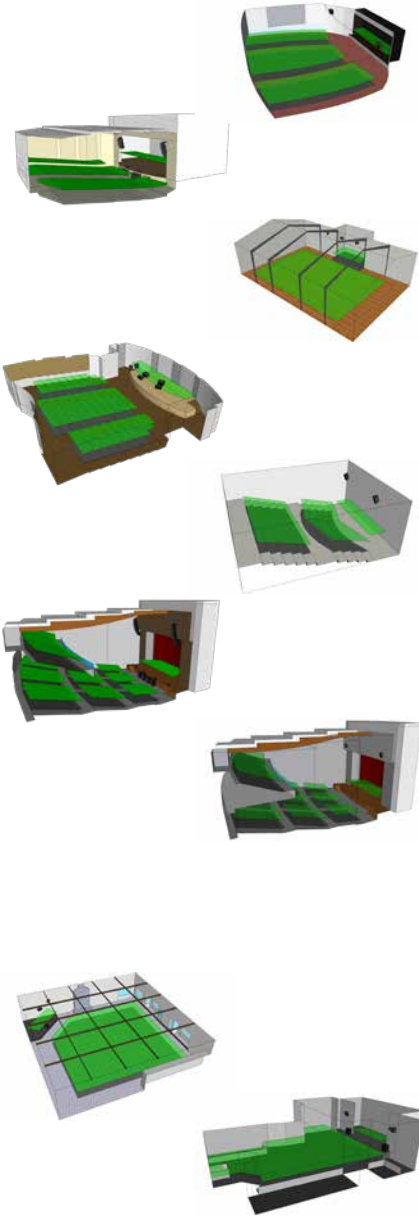

School Auditorium
 'Deep Sectional Seating' Page 4

Intimate Performance Space
 'Slightly Sloped Seating' Page 5

Multipurpose "Gymnatorium"
 'Flat Single-Level Seating' Page 6

Presentation Auditorium
 'Tiered Sectional Seating with Raised Stage' Page 7

Lecture Hall
 'Steep Tiered Seating' Page 8

Community Theater
 'Sloped Seating with Balcony - Option 1' Page 9

Community Theater
 'Sloped Seating with Balcony - Option 2' Page 10

Multi-Level Venues
 'Additional Considerations' Page 11

Small Restaurant / Lounge
 'Intimate Seating with Lower Ceiling' Page 12

Nightclub / Performance Space
 'Open Seating / Dance Floor with End Stage' Page 13

Designer Tips & Tricks
 'Projection and Coverage Patterns' Page 14

I SERIES
 'BalancePoint™ Flyware' Page 15
 'Modular Vertical Array' Rigging Accessories Page 16

Inside This Guide

Image Key

Green Planes/Lines: the audience or listener level on the full color images
Pink Lines: the mid-line (on-axis) coverage of each loudspeaker (on Side and Top views)

Technical Considerations
 'Amplified Loudspeaker Controllers' Page 17

Loudspeaker Specifications Page 18

School Auditorium

'Deep Sectional Seating'



IP6/8-1152 with
BalancePoint™ Fly Rails
(BFR22)

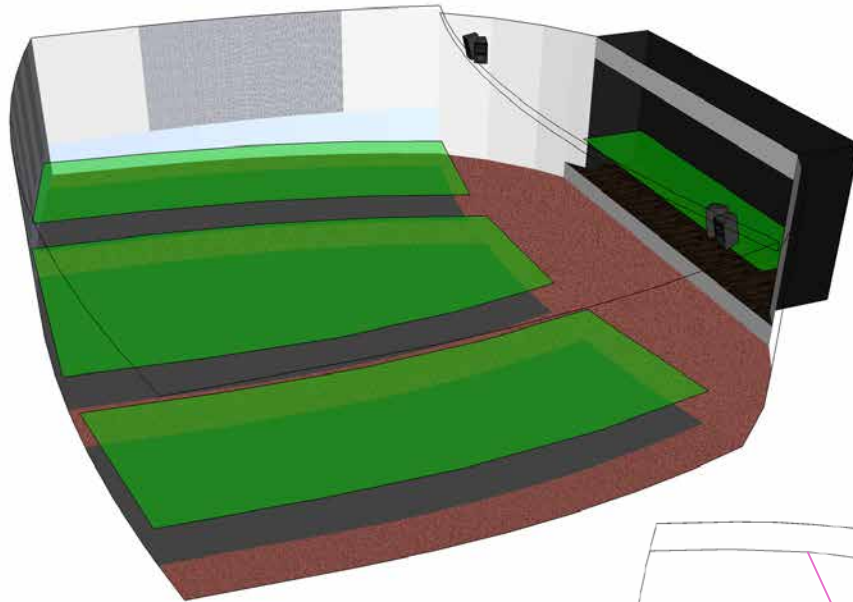

Center cluster
IP6-1152 with
IAF55
(optional)

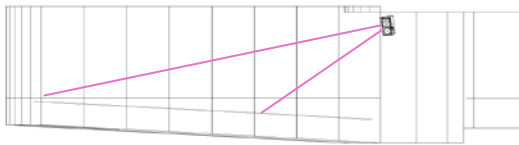

Side

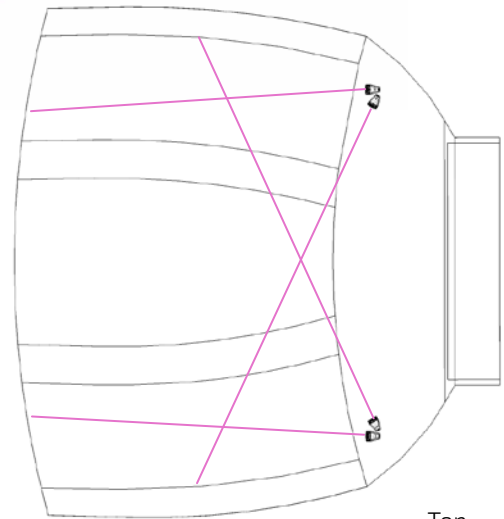

Top

Installation Description:

This dedicated performance space may need to cater to a wide range of events.

Coverage Notes:

For music events, the wide imaging of a Left/Right "stereo" array offers spatial advantages while lecture events are best reinforced by a centrally oriented array. Theatrical events benefit from the imaging capabilities of both, however sight line considerations may dictate one or the other.

Ideally these spaces benefit from a true Left/Center/Right layout. Each array must fully address all seating areas. Each portion is addressed separately from the mixing console to allow the mix operator to direct stereo, monaural, or specially panned signals to each array to best support the presentation.

It is more important to follow the seating lines and stage width to configure the array for coherent coverage. In some cases single L/R loudspeakers can provide sufficient coverage, but in many cases a pair is needed on both sides to provide enough horizontal coverage. Refer to the Tips and Tricks Figure 2 on page 14.

* Recommended Amplified Loudspeaker Controllers- minimum recommended for low impedance operation with channels maximized.

Left/Right Coverage:

Four (4) IP600/800
(various horn options)

Two (mirror image) arrays cover the entire space providing 'stereo' sound.
One (1) ALC-3202D*

Center Array (optional):

Three (3) IP600/800 (coverage)
Centrally consolidated and arrayed to cover the full audience area.
One (1) ALC-3202D*

Subwoofer (optional):

When possible, distributing subwoofers across the front of the stage offers even coverage, but mounting them overhead can preserve floor space.

Suggested model families: I SERIES (IP600/800, IS600/800) and V SERIES (V2-6, V2-26, V2-8, V2-28, V2-32, V2-35)
Amplified loudspeaker controller* for V SERIES substitution for either array option is (1) ALC-404D*

Intimate Performance Space

'Slightly Sloped Seating'

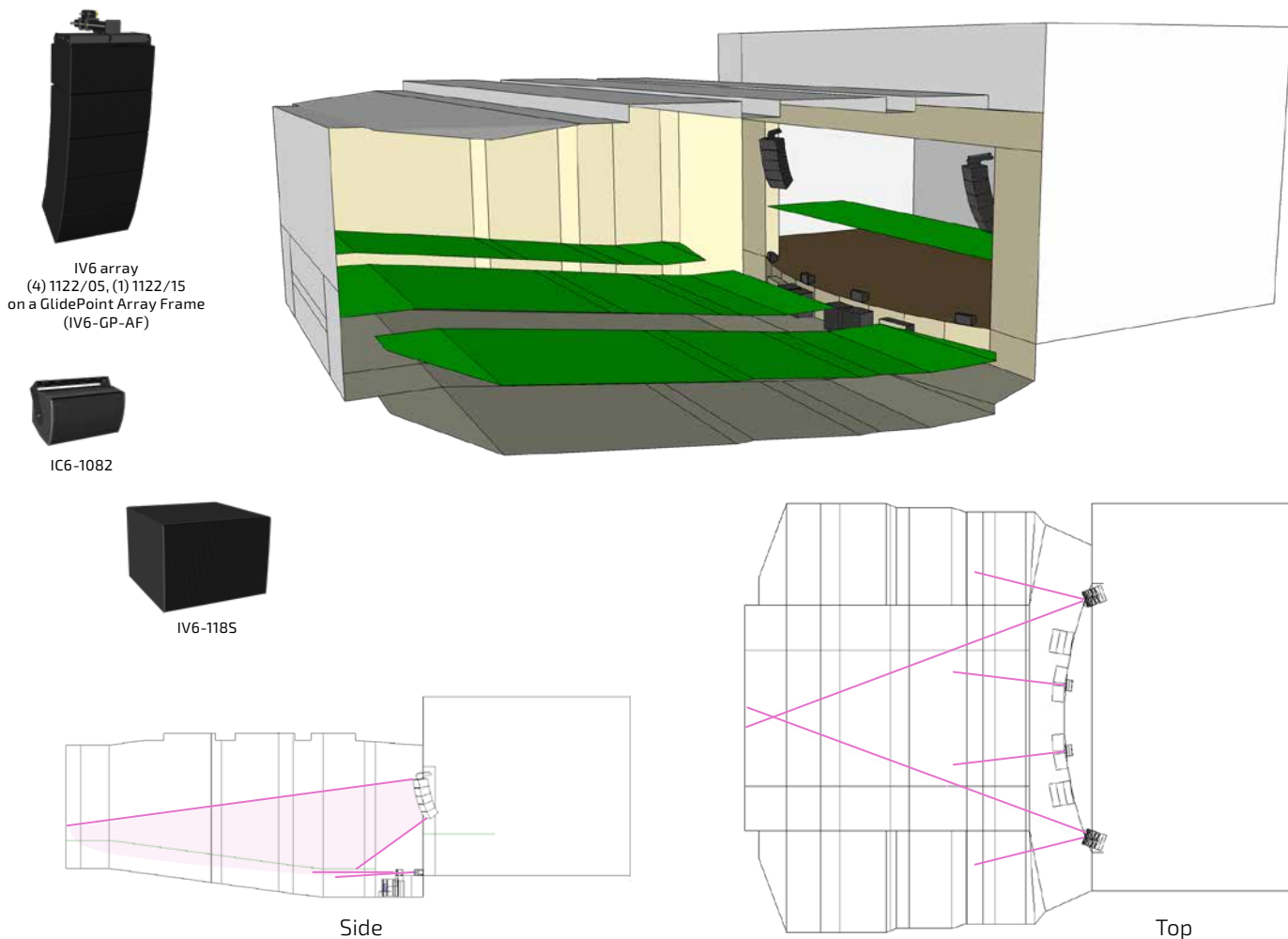

Installation Description:

A smaller-sized performance venue may not present difficult acoustics. It might benefit well from either a point-source or line-source system. In this case, an IV6 Modular Vertical Array offers a wide range of capability from soft, articulate presentations to high impact music. The adjustable directivity offers the opportunity to tailor the coverage to exactly the shape of the space, maximizing the listener's experience and keeping music clear at all sound pressure levels.

Coverage Notes:

Combining both types of IV6 array elements allows the array to address both close and far seating from a low trim height. Tightly packed 5-degree modules at the top focus sound to the rear seats while the bottom 15-degree module wraps coverage down to the front rows that are very close to the stage. Passive attenuation assigned to modules in the array further smooths out the coverage uniformity.

To provide even bass coverage to all patrons, the subwoofer array uses slightly different delay and low pass settings to prevent narrowing the low-frequency coverage. This approach can apply as a design strategy for similar venues with wide prosceniums and a need for multiple subwoofers (for higher output).

* Recommended Amplified Loudspeaker Controllers- minimum recommended for low impedance operation with channels maximized.

Coverage

Two (2) IV6 Arrays
(Each array has [4] 1122/05 and [1] 1122/15 elements)

Two (mirror image) IV6 short arrays (increasing curvature from top to bottom) cover the entire space providing even SPL throughout by utilizing our Passive Acoustic Optimization tool in EASE® Focus 3.

Four (4) IC6-1082/26
Front fills provide localization for patrons near the stage.

Four (4) IV6-1185 subwoofers
Two pair are positioned on their side panels back-to-back to maximize output while maintaining aisle space for the patrons in the front row

**Two (2) ALC-3202D* and
One (1) ALC-404D***

Multipurpose "Gymnatorium"

'Flat Single-Level Seating'

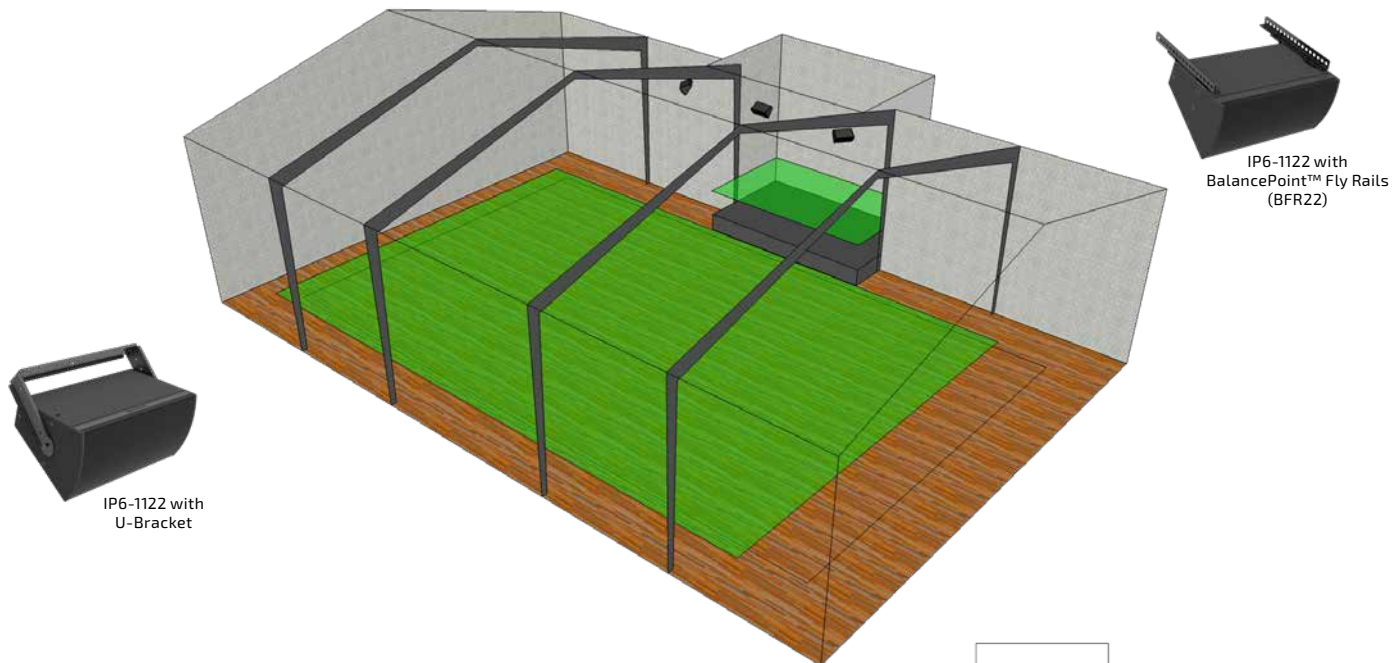

IP6-1122 with U-Bracket

IP6-1122 with BalancePoint™ Fly Rails (BFR22)

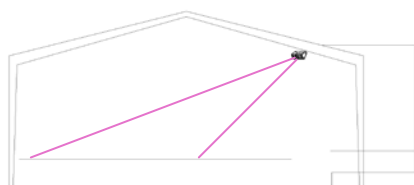

Side

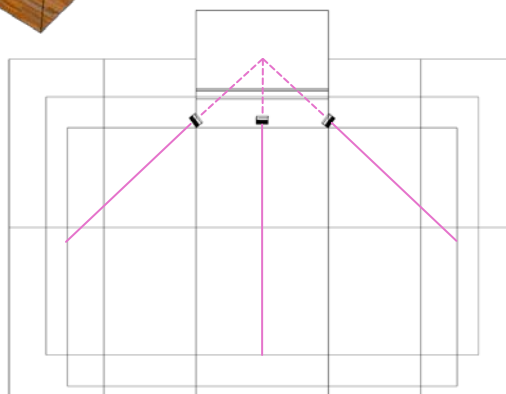

Top

Installation Description:

This multipurpose room is used for a variety of activities, functioning as a cafeteria, gym, auditorium or assembly space. It may be challenging to provide a single audio solution that addresses all of these uses and related events.

Coverage Notes:

The Side and Top views above show an array of horizontally oriented loudspeakers¹ that provide coverage to the left, center and right of the space. Each loudspeaker likely needs a wider vertical dispersion and a narrower horizontal pattern to provide the best coverage. Usually, the loudspeaker's on-axis projection should be aligned with the center of the platform (shown by dashed lines on the Top View).

Amplified Loudspeaker Controller:

For (3) IP6-1122 system - One (1) ALC-1604D*

Subwoofer (optional):

When possible, distributing subwoofers across the front of the platform offers even coverage, but mounting them overhead may be necessary to preserve floor space.

Related Design:

Larger halls like this with dedicated seating for sports, may benefit from a concurrent layout from Community's Sports Sound Loudspeaker System Design Reference Guide.

¹Horns are rotated 90° from factory standard configuration to maintain the coverage pattern.

* Recommended Amplified Loudspeaker Controllers - minimum recommended for low impedance operation with channels maximized (without subwoofer addition).

Presentation Auditorium

'Tiered Sectional Seating with Raised Stage'



IP6/8-1122
and IS6/8-212 with
BalancePoint™ Fly Rails
(SBR54)

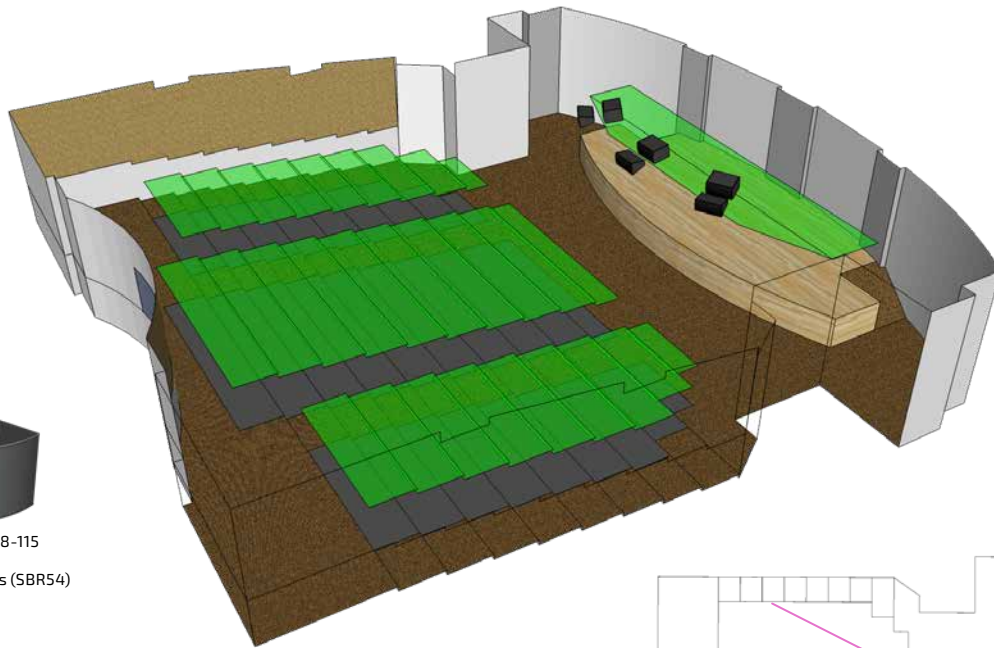

IP8-0002 with IS6/8-115
mounted on
BalancePoint™ Fly Rails (SBR54)

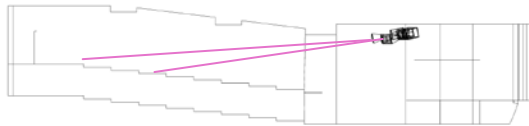

Side

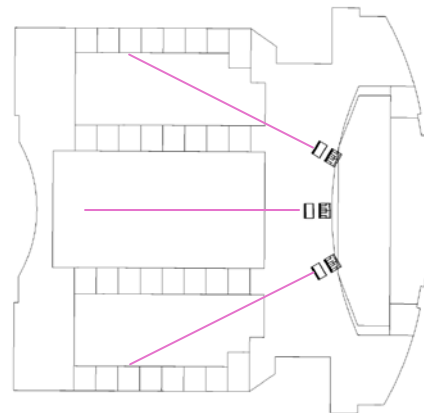

Top

Installation Description:

This is primarily a lecture space. It may also host a wide range of activities, including presentations or entertainment events, when it must deliver full-bandwidth audio. It has a raised stage and lower front ceiling necessitating low profile loudspeaker solutions.

Coverage Notes:

An exploded array of horizontally oriented medium-format loudspeakers covers each section (Left/Center/Right [LCR]), and in this case subwoofers are mounted behind for full low frequency support. Depending upon the ceiling heights and the depth of the room, the space may be better served with two sets of arrayed loudspeakers (similar to Distributed Source configuration on the Lecture Hall, next page), with one set covering the front half of the seating and another placed about halfway back addressing the upper audience. Additional stereo loudspeakers can be included to support LCR type events or occasional cinema use.

Unless this space is exclusively used for lectures, subwoofers are needed. Due to limited floor space, they can be mounted overhead (as shown). For a deeper bass impact and more even bass coverage, array compact subwoofers along, or concealed in, the down-stage face of the stage.

* Recommended Amplified Loudspeaker Controllers - minimum recommended for low impedance operation with channels maximized (without subwoofer addition).

Left/Center/Right (LCR) Coverage:

Three (3) IP600/800
(various horn patterns)

Each covers a section with subwoofers mounted behind in landscape orientation.

Two (2) ALC-1604D*

An IP8-0002 mid-high with an IS6/8-115 subwoofer mounted behind is another option, and includes:

One (1) ALC-1604D* and

One (1) ALC-404D*

Additional Subwoofers (optional):

Spaced across the front of the stage area for extra bass support of cinema or musical events.

Suggested model families: I SERIES (IP600/800, IS600/800) and V SERIES (V2-6, V2-26, V2-8, V2-28, V2-32, V2-35, VLF208LV)

Recommended* Amplified Loudspeaker Controllers for V SERIES in this application is two (2) ALC-404D*

Lecture Hall

'Steep Tiered Seating'



IP6/8-1122
with U-Bracket
[Front Source]



IC6-1082
with U-Bracket
[Distributed Source]

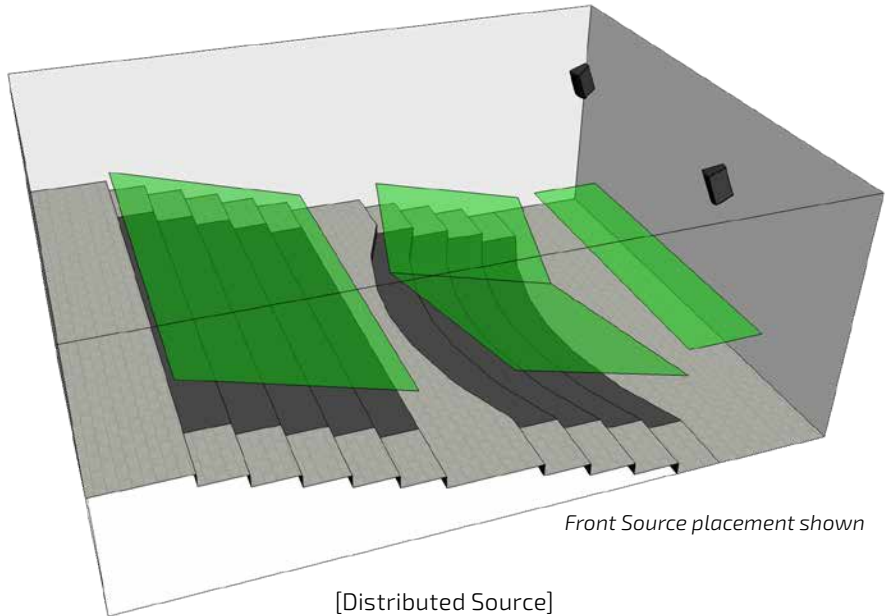

[Front Source]

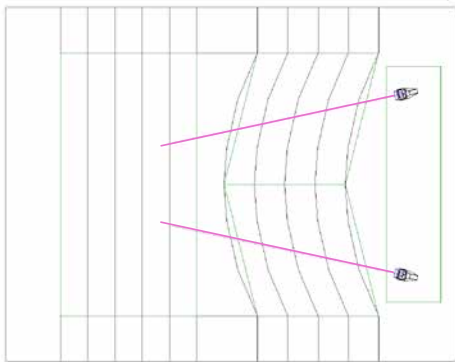

Top

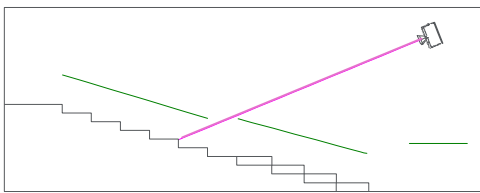

Side

[Distributed Source]

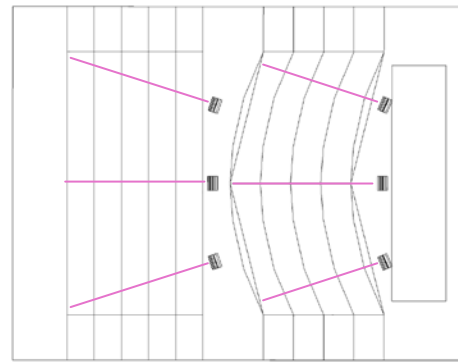

Top

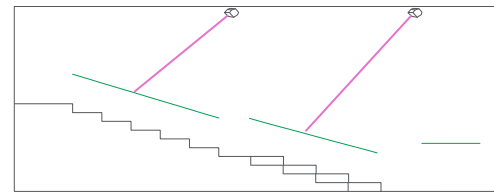

Side

Installation Description:

This is a space usually dedicated to lectures or small theatrical screenings. The seating area is sharply raised.

Coverage Notes:

Smaller format lecture spaces can benefit from several different approaches which have trade-off advantages:

Front Source [Left/Right]: Two sources spaced strategically create an acoustic "null" in the direct sound arriving to the center of the presentation area. Microphones in this area will benefit from increased GBF (Gain Before Feedback). Pay close attention to horn pattern selection to ensure that excess coverage does not reduce GBF for the presenter.

Distributed Source: To raise GBF and improve localization for most seats, an array of two or three compact models addresses each of the two seating zones. This reduces the projection distances and the direct SPL projected onto the presenter's area. It can also help with video projector paths, sight lines, and aesthetics.

One (1) ALC-404D* will work for both coverage options shown.

* Recommended Amplified Loudspeaker Controllers - minimum recommended for low impedance operation with channels maximized.

Front Source Coverage:

Two (2) IP600/800
(*narrow horizontal coverage*)

Two (mirror image) loudspeakers cover the entire space with the least number of loudspeakers

Suggested model families:
I SERIES (IP600/800) and V SERIES (V2-26, V2-28, V2-32, V2-35)

Distributed Source Coverage:

Four to Six (4-6) IC600

Two to three compact models arrayed to cover each half (lower/upper) of the seating sections

Suggested compact model families:
I SERIES (IC600) and V SERIES (V2-6, V2-8, V2-26, V2-28)

Community Theater

'Sloped Seating with Balcony - Option 1'

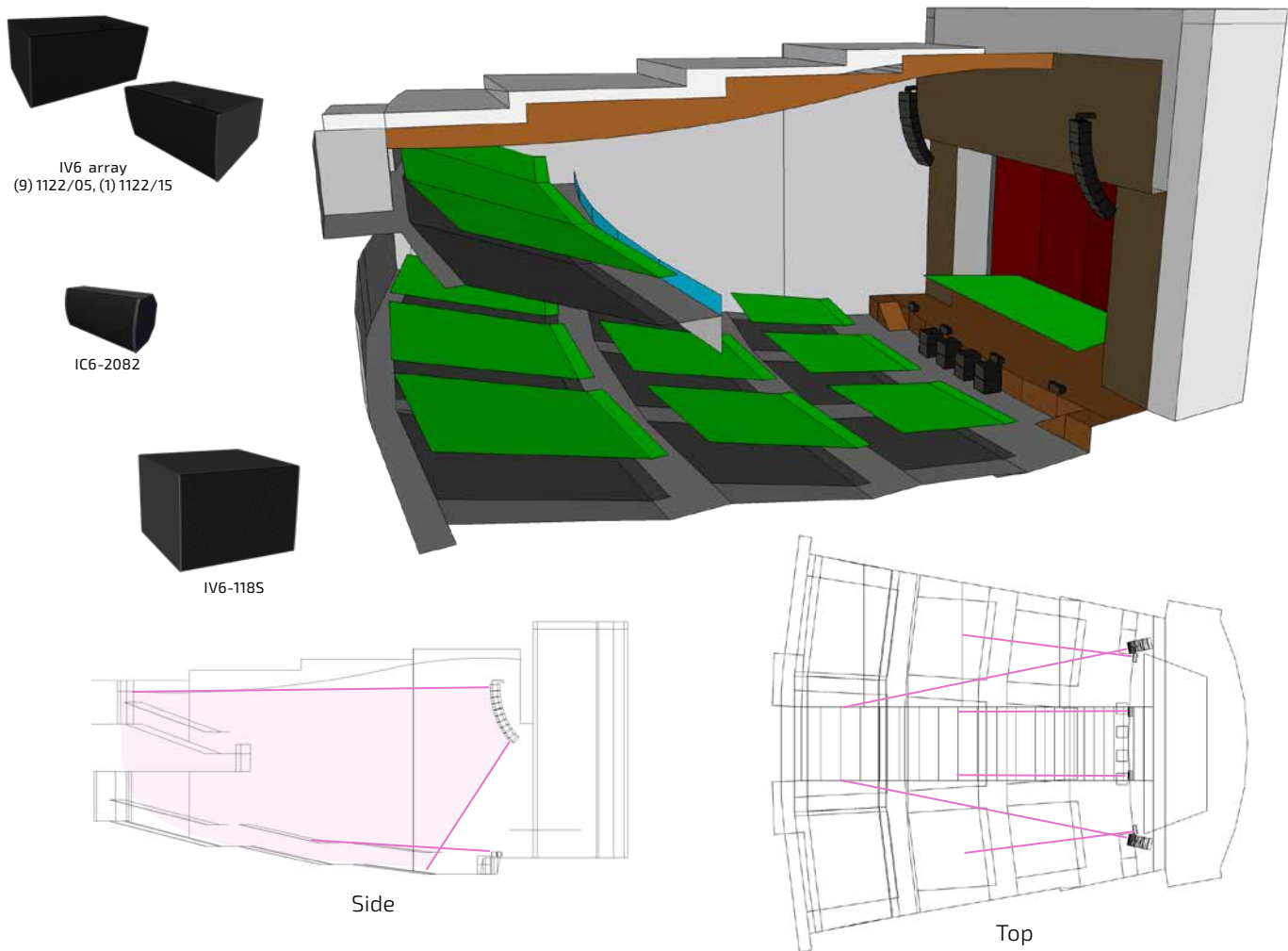

Installation Description:

A fully equipped performance venue that hosts local, regional, and national acts, this medium-format performing arts hall offers broad seating areas on the first level plus additional balcony seating.

Coverage Notes:

For higher output levels or acoustics that present too much naturally reflective sound, a more directional loudspeaker system will deliver clearer music and voice articulation. The IV6 Modular Vertical Array offers line-array type directivity. Two IV6 arrays are configured to address all seating areas with supplemental front-fill loudspeakers arrayed across the stage lip. While there are no line-of-sight disruptions from any seats to a large portion of the array, there may be a need for supplemental fill speakers for the last rows on the first level.

Grouping subwoofers close together achieves higher levels from a smaller number of subwoofers. To provide even bass coverage to all patrons, the outer subs are signal-processed with a short delay and a lower frequency Low Pass Filter (~60Hz) than the inner subs (~80Hz). This approach can apply as a design strategy for similar venues with wide prosceniums and a need for several subwoofers (for higher output).

* Recommended Amplified Loudspeaker Controllers - minimum recommended for low impedance operation with channels maximized.

Coverage

Two (2) IV6 Arrays
(Each array has [9] 1122/05, [1] 1122/15 elements)

Two (mirror image) IV6 spiral arrays (increasing curvature from top to bottom) cover the entire space providing even SPL throughout, utilizing progressive attenuation settings from our Passive Acoustic Optimization tool in EASE® Focus 3.

Four (4) IC6-2082/26

Front fills provide localization for patrons near the stage.

Eight (8) IV6-118S subwoofers

Four ground stacks of two (2) subwoofers each are spaced below the front of the stage facing the audience.

Four (4) ALC-3202D* and One (1) ALC-404D*

Community Theater

'Sloped Seating with Balcony - Option 2'

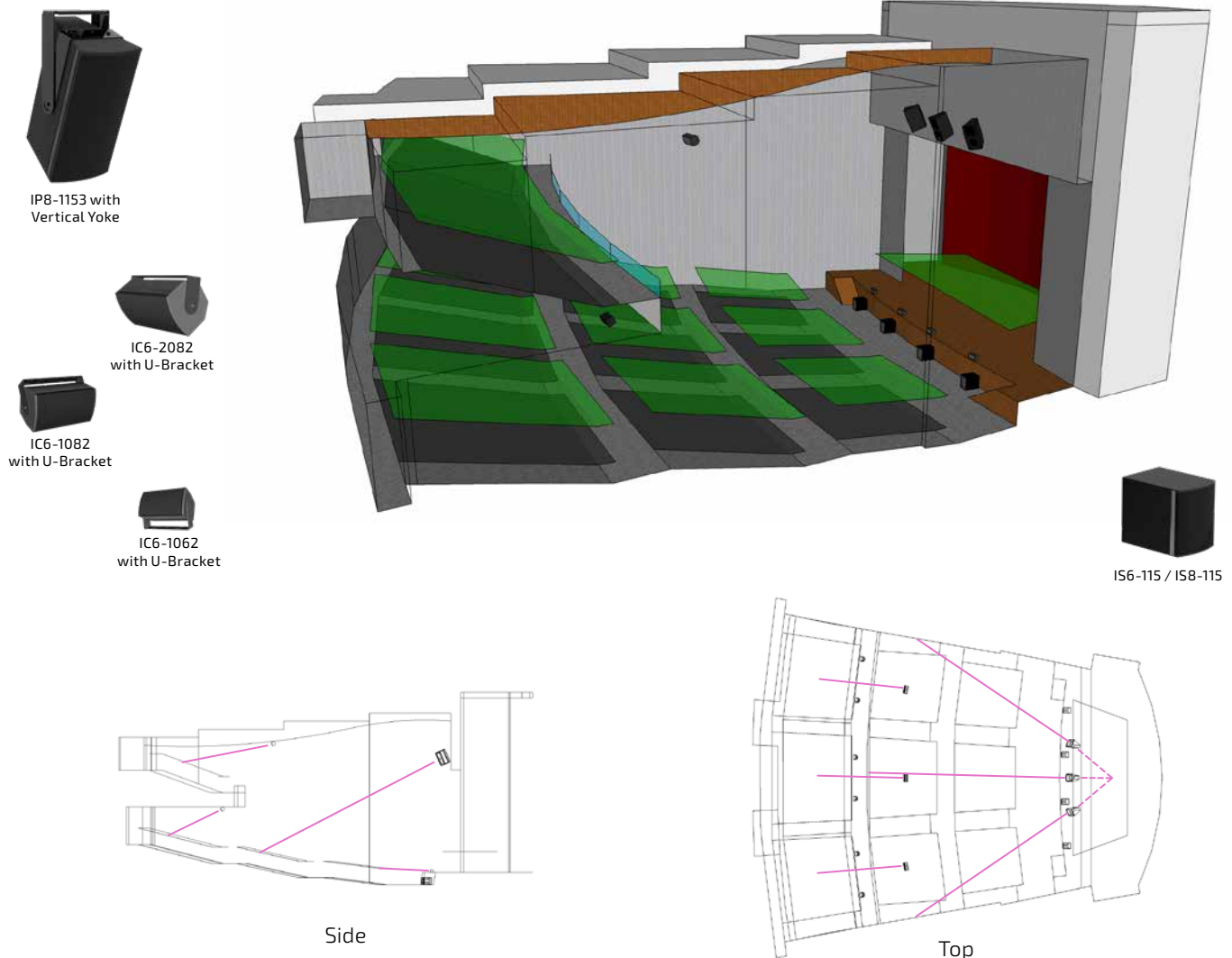

Installation Description:

A fully equipped performance venue that hosts local, regional, and national acts, this medium-format performing arts hall offers broad seating areas on the first level plus additional balcony seating.

Coverage Notes:

A medium to large-format loudspeaker array addresses the majority of the first floor seating. In this case, a set of three IP8-1153/64s arranged in a monaural exploded array reinforces on-stage action while preserving localization for the audience. The main array's coverage partially extends into the under/over balcony areas, but supplemental loudspeakers (IC6-1082 under balcony, IC6-2082 over balcony) ensure uniform coverage. Having supplemental fills allows for specific system adjustments to cover each area that acoustically differs from the larger open main floor space.

Amplified Loudspeaker Controllers:

Two (2) ALC-1604D* and One (1) ALC-404D*

* Recommended Amplified Loudspeaker Controllers - minimum recommended for low impedance operation with channels maximized (without subwoofer addition).

Subwoofers:

For purpose-built venues of this type, subwoofers can often be integrated into, or perhaps concealed within, the stage front. Where possible, array the subwoofers evenly across the front of the stage to avoid the "power alley" effect caused by positioning them at the extreme right & left of the proscenium. Overhead subwoofer suspension may warrant cardioid or forward-steered arrays to raise bass levels in the seating while preserving GBF (Gain Before Feedback) on the stage.

Multi-Level Venues

'Additional Considerations'

Notes

1. To preserve sight lines, the main loudspeakers usually must be kept above the "blue" sight line shown for the first floor rear seat listeners (or any positions where the loudspeakers might obstruct the view of the stage).
2. The under-balcony IC6-1082 fill loudspeakers should be located slightly down-stage of the "blue" sight line to the main PA loudspeakers.
3. Similarly, the over-balcony IC6-2082 supplemental loudspeakers should be positioned above the "dashed orange" sight line to the stage.

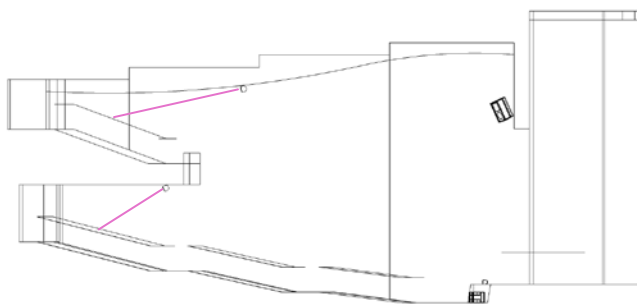
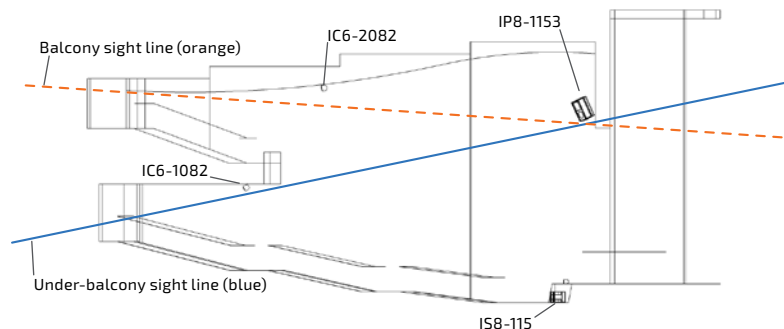

4. For large balcony areas, instead of the IC6-2082s shown here, consider larger-format IP6/8-1122 two-ways, or the unique IP8-0002 loudspeaker which features the same mid-high frequency driver components as IP8-1153 three-way loudspeakers.
5. For both the under- and over-balcony listening areas, adjust the signal delays to preserve the illusion that the sound provided by the balcony coverage loudspeakers is actually coming from the stage.

6. When the main loudspeaker array must trim high relative to the front seating, localization levels in front may be poor (light green shaded area). "Localization" refers to the direction that sound appears to be coming from - either overhead or on-stage. To rectify this, consider placing IC6-1062 fills along the stage lip to support the front seating (light blue shaded area). Coverage of the under- and over-balcony fills is shown in light orange.

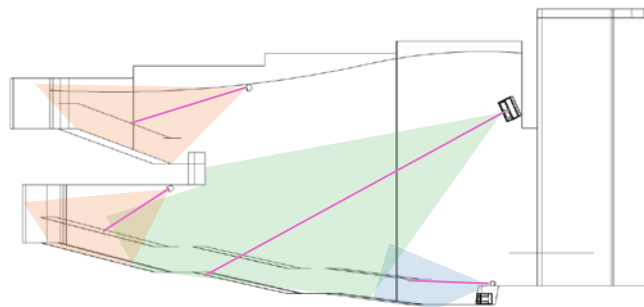

Small Restaurant / Lounge

'Intimate Seating with Lower Ceiling'



IC6-1082



IP6-1122 with U-Bracket



IP8-0002 with IS6-115 mounted on an SBR54

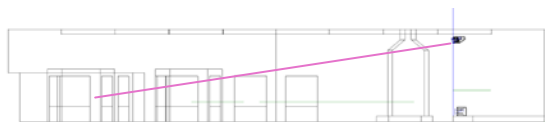
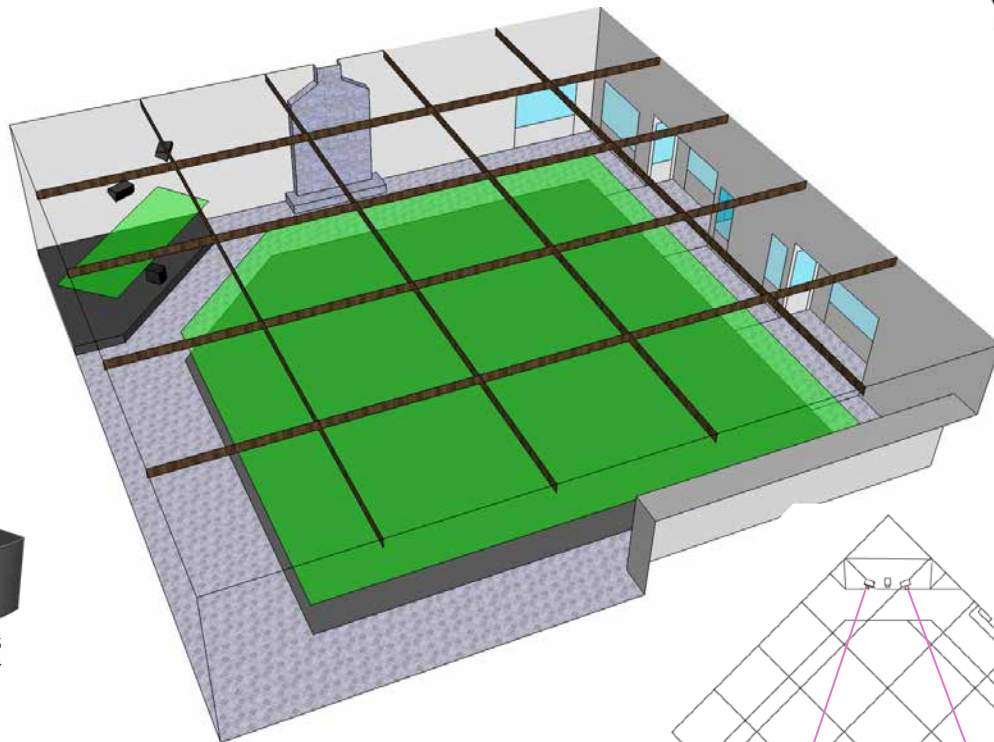

Side

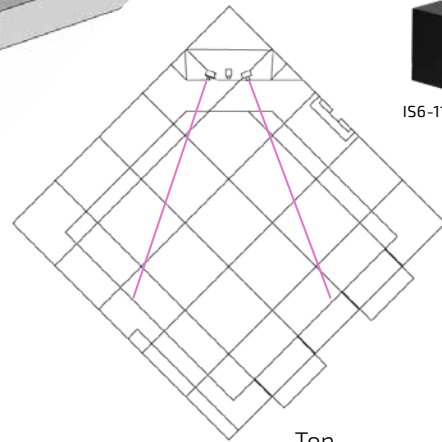

Top



IS6-115 / IS8-115

Installation Description:

This is typically a small restaurant, lounge or club with a smaller performance space usually in a corner or off to the side.

Coverage Notes:

While the musicians may be isolated in a corner (to maximize table space), patrons are able to enjoy their meal and have a balanced musical experience without the "hot spots" common to many portable systems brought in just for the performance.

In this example, a monaural pair of medium-format horizontally mounted I SERIES IP6-1122s addresses the space fairly evenly. The larger waveguide in these models helps ensure that further seating areas are reached as well as closer seats. A central subwoofer is on the floor for bass support. If extended coverage is needed, IC600 compact models are good choices.

For a distributed foreground or background music listening experience, the compact IC600 or V SERIES models offer professional fidelity and system longevity for maximum return on investment to the establishment. Don't forget the subwoofers! They are an integral part of the audio system, delivering the low frequency component of the full musical spectrum expected by today's listeners.

Amplified Loudspeaker Controller:

One (1) ALC-1604D* for either I SERIES option

* Recommended Amplified Loudspeaker Controllers - minimum recommended for low impedance operation with channels maximized.

Left/Right Coverage:

Two (2) IP6/8-1122 horizontally mounted from the ceiling at the front of the performance area.

OR

Two (2) IP8-0002 mounted from the ceiling at the front of the performance area.

Subwoofers:

The images show a single subwoofer centrally placed on the floor in front of the performance space. If floor space is not available a single driver IS6/8-112 or IS6/8-115 subwoofer can be mounted behind the IP8-0002 using BalancePoint™ Fly Rails.

Suggested model families: I SERIES (IP600/800, IS600/800) and V SERIES (V2-6, V2-26, V2-8, V2-28, V2-32, V2-35, V2-212S or VLF208LV)

Amplified loudspeaker controller for V SERIES in this application is one (1) ALC-404D*

Nightclub / Performance Space

'Open Seating / Dance Floor with End Stage'

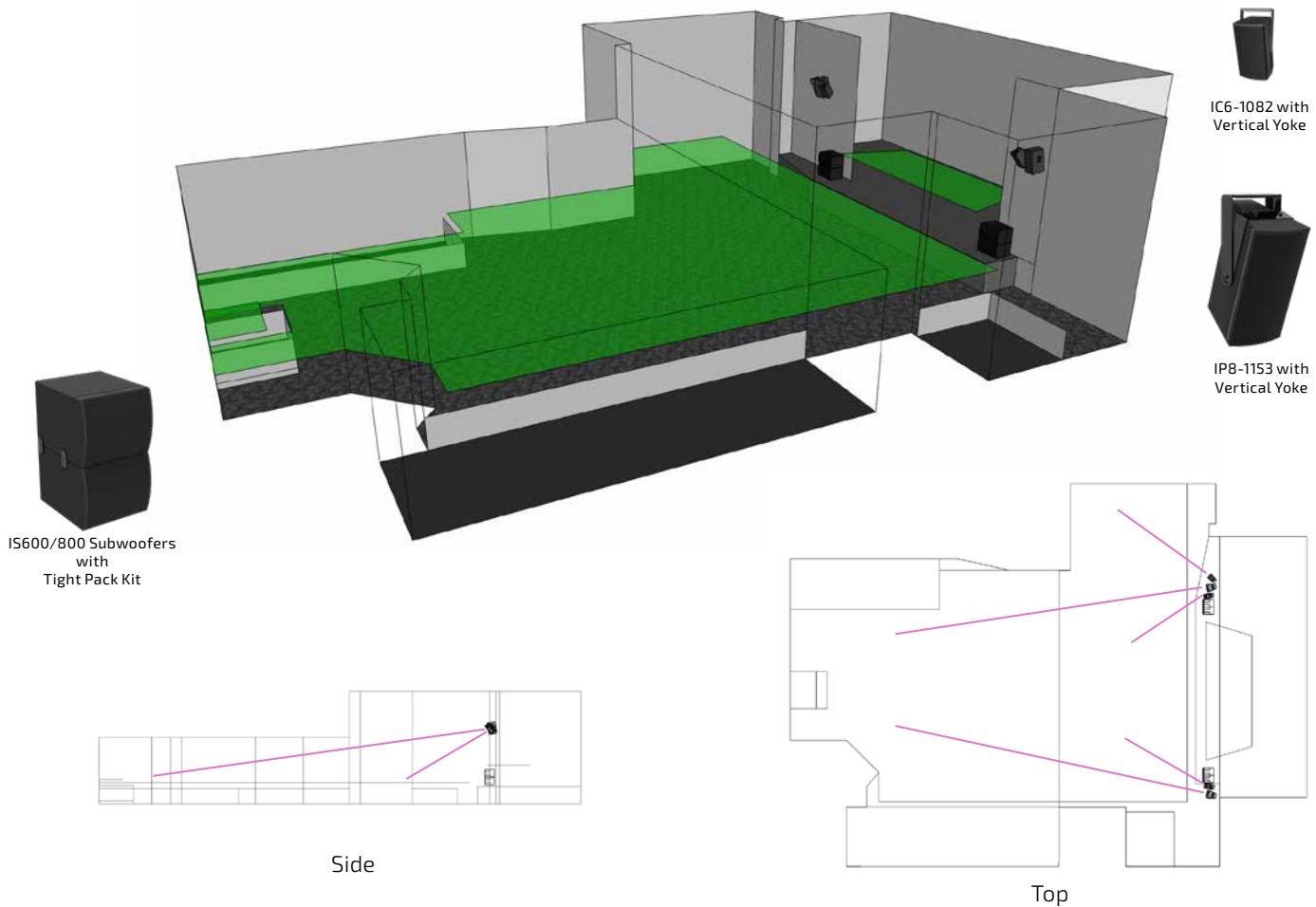

Installation Description:

This may be a converted warehouse, reclaimed historical structure, or an extension on a pub or dining establishment, but everyone knows it as the local venue to check out the up-and-coming acts. By design, it needs a bass boosted, robust audio system that energizes the crowd and encourages dancing.

Coverage Notes:

For broad-spectrum performances in support of a wide range of instrumentation three-way mains supplemented by medium to large-format subwoofers are mandatory. Vocalists and nearly all musical instruments convey fundamental mid-range information. Therefore, it is important to support each band member individually to maximize clarity. Offering low distortion transducers, the IP8-1153, V2-32, and V2-35 models are usually the best choice for "Mains". Select subwoofer complements based on Max SPL ratings that exceed the target broadband SPL by at least 10 dB.

Array formats are often Left/Right – particularly in shorter ceiling scenarios. Where trim heights allow, consider the benefits of a centrally oriented array to primarily reinforce vocals and allow for mix imaging options.

[Be sure to encourage the establishment to provide hearing protectors to the patrons.]

Left/Right Coverage:

Two (2) IP8-1153 for the Mains, with additional IC600 compacts mounted to the inside providing front fill support. IC600 models can also cover any ancillary spaces on the sides.

One (1) ALC-1604D* and
One (1) ALC-404D*

Subwoofers:

Four (4) IS6/8-118 stacked subwoofers are shown. Dual or stacked subwoofers flank the performance area on-stage or at floor level.

Two (2) ALC-3202D* (bridged)

Suggested model families: I SERIES (IP600/800, IS600/800) and V SERIES (V2-6, V2-26, V2-8, V2-28, V2-32, V2-35)

* Recommended Amplified Loudspeaker Controllers - minimum recommended for low impedance operation with channels maximized.

Designer Tips & Tricks

'Projection and Coverage Patterns'

What is the effective projection distance for a point-source loudspeaker?

Use the 3:1 Rule for D2 (Distance to furthest listener) and D1 (Distance to closest listener) to approximate the area over which the loudspeaker provides +/-3dB variation in SPL: $D2 \leq D1 \times 3$.

Which vertical horn pattern do I choose when there are so many options? See Figure 1.

- Determine the axial aim point to the rear seating.
 - Depending on how much the wall surfaces behind the rear seats present a "slap back" echo, defines how sharp the downward aiming angle should be.
 - For lower trim heights where the loudspeaker must project the full depth of the space, aim for the furthest listeners almost exclusively. Front seats will benefit by close proximity.
 - For higher trim heights or distributed arrays, the aim point will likely be toward the rear third or rear half of the seating.
- Choose the Nominal Vertical Coverage Angle based on the aiming axis chosen in Step 1 that will include the front seating with priority over the rear seats.
- If the vertical angle becomes too tall and will project too much on the ceiling or other non-occupied areas, then consider a shorter vertical coverage angle and supplement the front seating areas with fill speakers:
 - Fill speakers can be mounted along the leading edge of the platform to address the first couple rows (i.e. Compact V SERIES or I SERIES models). This will also help those listeners better localize the direct sound to the platform.
 - Otherwise, consider a "down fill" position under the main loudspeakers with a wider angle, lower directivity product.

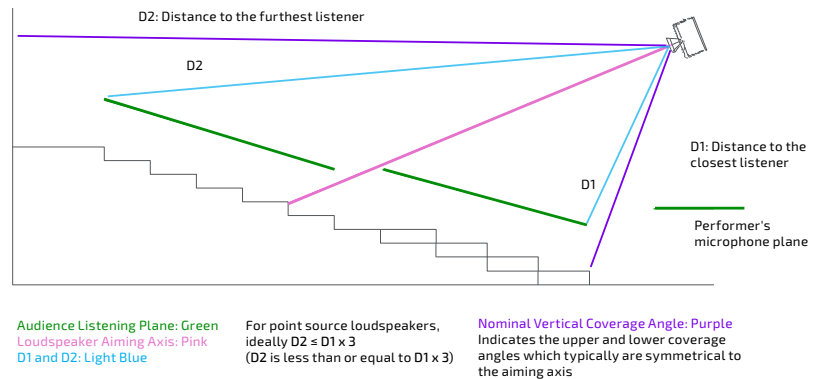

Figure 1. Determine the vertical horn pattern

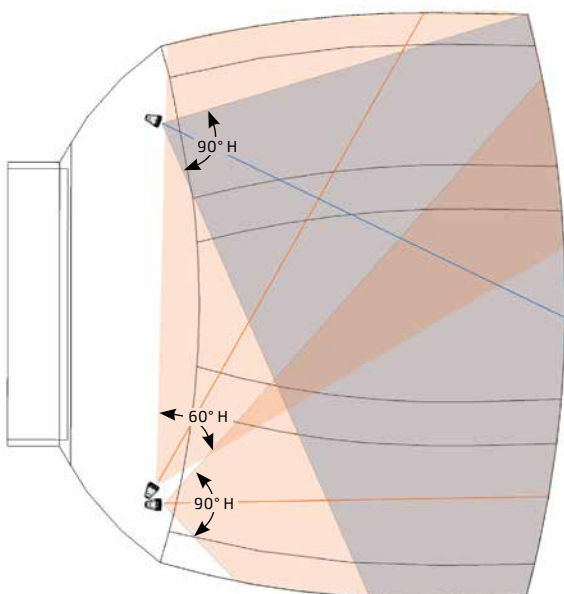

Figure 2. Coverage of single vs dual loudspeakers per side

How do I choose the horizontal horn pattern?

Measure the angle from the furthest listener left to right (from an individual loudspeaker or group of loudspeakers).

Choose a single horn pattern for an individual loudspeaker equal to that angle.

When the coverage need is wider than a single loudspeaker can address, divide the coverage between two loudspeakers and allow 5 to 10 degrees to accommodate the overlap.

Keep in mind that the 3:1 Rule also applies in the horizontal plane, and there is a limit to how far a single loudspeaker can project along the breadth of the seating.

Also, the loudspeakers aimed toward the front/center seating can be level adjusted to "amplitude shade" the coverage and maintain proper SPL uniformity.

Figure 2: The dual coverage (light orange) offers a more complete coverage of the full seating area. The single loudspeaker (grey) misses the outside and front middle audience sections.

I SERIES

'BalancePoint™ Flyware'

Refer to the I SERIES BalancePoint™ Flyware Accessory Guide for an inclusive installation guide for all of the kits. Clicking on each of the [blue](#) model numbers will bring up the individual kit assembly instructions.

BalancePoint™ Fly Rails

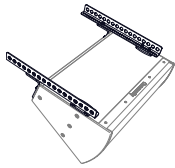

BFR22H: BalancePoint™ Horizontal Fly Rails
- fly a single enclosure (landscape orientation)

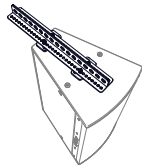

BFR22V: BalancePoint™ Vertical Fly Rails
- fly a single enclosure (portrait orientation)



SBR54: Subwoofer behind BalancePoint™ Fly Rails (54")
- adds one or two subwoofers behind any array configuration

U-Brackets and Vertical Yokes

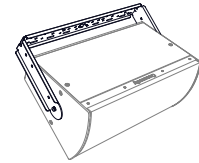

IUB1122, IUB1152, IUB1153: U-Brackets
- mount and aim single full-range loudspeakers
IUB1122WRG, IUB1152WRG, IUB1153WRG, IUB0002WRG, IUB1125WRG: Stainless steel U-Brackets for weather-resistant versions of loudspeakers and subwoofers

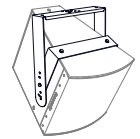
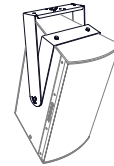

IVY1122, IVY1152, IVY1153, IVY0002: Vertical yokes - vertically mount and aim single full-range loudspeakers (model specific)

Horizontal Array Kits

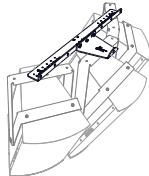

IAF40 (2-way), IAF55 (3-way): Isometric Array Frames
- for two to three loudspeakers in portrait or landscape orientation (Requires U-Brackets or Vertical yokes)

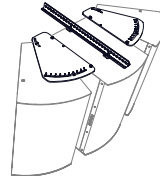

HAB-BFR38 (2-way), HAB3-BFR38 (3-way): Horizontal Array Brackets with BalancePoint™ Fly Rails Kit - to array two full-range cabinets with a subwoofer in between

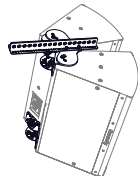

HSB-BFR22 (2-way), HSB3-BFR22 (3-way): Dual Horizontal Splay Kits
- horizontally array two full-range models

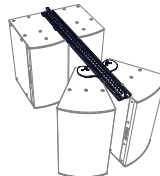

HSB-SBR54 (2-way), HSB3-SBR54 (3-way): Horizontal Splay Brackets with BalancePoint™ Fly Rails Kit - to array two full-range loudspeakers with subwoofer(s) behind

Array Accessory Kits



DFS: Downfill Splay Bracket - to add a downfill loudspeaker to any array



HVS (2-way), HVS3 (3-way): Horizontal/Vertical Splay Brackets - to add one additional loudspeaker to an array

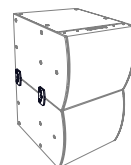

TPK: Tight Pack Kit - to connect any pair of loudspeakers or subwoofers that share common suspension points

Vertical Array Kits

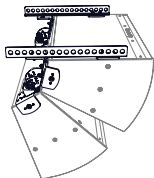

VSB-BFR22 (2-way), VSB3-BFR22 (3-way): Vertical Splay Kits - to vertically array two full-range models

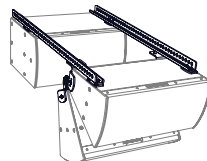

VSB-SBR54 (2-way), VSB3-SBR54 (3-way): Vertical Splay Brackets with BalancePoint™ Fly Rails - to array two full-range loudspeakers with subwoofer behind

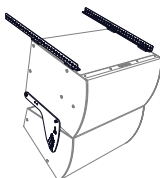

VAB-BFR38: Vertical Array Brackets with BalancePoint™ Fly Rails Kit
- mount and aim a full-range cabinet under a subwoofer

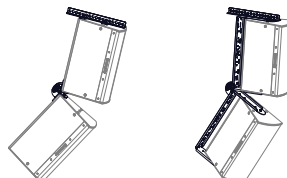

DVS-BFR22: Dual Vertical Splay with BalancePoint™ Fly Rails - to vertically array and aim two loudspeakers or loudspeaker/subwoofer combination (Can also be used with one or two U-Brackets)

I SERIES

'Modular Vertical Array' Rigging Accessories

Refer to the IV6 Indoor Rigging Frames, Accessories and Safety Guide for a comprehensive installation guide and additional information about each accessory.

Splay Brackets

Splay brackets are required to connect the elements in the array. One pair must be ordered for each cabinet-to-cabinet connection.



IV6-S1
Pair



IV6-S2
Pair



IV6-S3
Pair

Accessories - optional



PY1-EN750-1550
Lift Point for Array
Frames

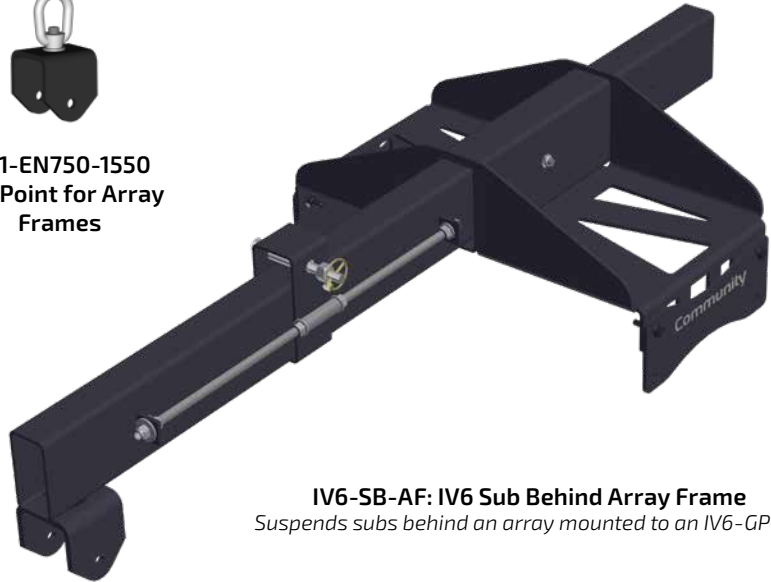

IV6-SB-AF: IV6 Sub Behind Array Frame
Suspends subs behind an array mounted to an IV6-GP-AF

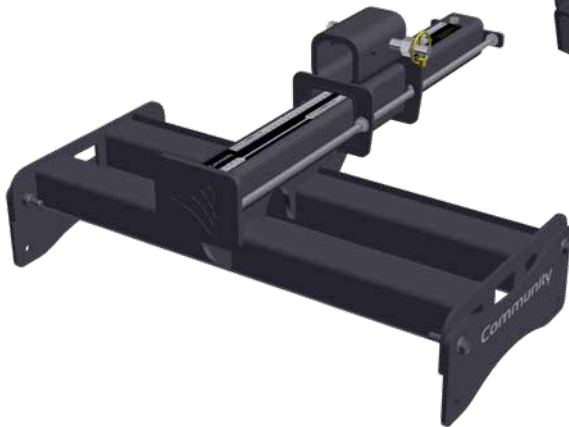

IV6-GP-AF: IV6 GlidePoint™ Array Frame
Can support up to sixteen IV6-1122s, or a combination of IV6-1122s and a few IV6-1185s



IV6-GP-AF and IV6-SB-AF



IV6-LAF-PBB: IV6 Light Array Frame/Pullback Bar
Can support up to ten IV6-1122s, or can be used at the bottom of a longer array as a pullback bar



IV6-LAU: IV6 Light Frame Adapter U-Bracket
Shown individually (at left) and in its normal use (right) attached to the IV6-LAF-PBB for under-balcony applications

Additional mounting and rigging accessories are available from Polar Focus (www.linearrayframes.com)

Technical Considerations

'Amplified Loudspeaker Controllers'



Community recommends our series of Amplified Loudspeaker Controllers (ALC) for all Community loudspeaker applications, like those shown in this application guide. ALCs provide all of the signal routing, zone switching, DSP processing, protective limiting, remote monitoring, and amplification functions needed between a mixer and the loudspeakers in virtually any Community Professional Loudspeakers application. Standard Ethernet communication protocols allow for fast system design, system control, and remote system monitoring. Analog and Dante® inputs are included in each model, for quick and easy integration into any new or existing system. Community-authored loudspeaker presets include equalization, high pass filters, and multi-stage limiters tailored to each model, ensuring consistent sound quality and full loudspeaker protection in every application.

ALC Application Note

Total available power can be safely distributed asymmetrically across the outputs in any combination of low impedance and 70V/100V loads. Power delivered from each output is individually managed; total shared power per ALC is monitored and limited independently by the power supply.

ALC-404D

- 4 inputs (Analog and/or Dante®)
- 4 channels of amplification and DSP processing
- Each channel provides up to 400W of power into low impedance or 70V/100V loads, stable to 2Ω
- In bridged mode, each pair of channels provides up to 800W into 8Ω, 4Ω, or 70V/100V loads
- Total shared power not to exceed 1200W
- Perfect for Small R SERIES, V SERIES, Compact I SERIES, W SERIES (W2), and ENT200 models, and zoned C SERIES & D SERIES applications

ALC-1604D

- 4 inputs (Analog and/or Dante®)
- 4 channels of amplification and DSP processing
- Each channel provides up to 1600W of power into low impedance or 70V/100V loads, stable to 2Ω
- In bridged mode, each pair of channels provides up to 3200W into 4Ω, or 70V/100V loads
- Total shared power not to exceed 4800W
- Perfect match for Larger R SERIES & W SERIES, I SERIES, IV6 and ENT-FR

ALC-3202D

- 2 inputs (Analog and/or Dante®)
- 2 channels of amplification and DSP processing
- Each channel provides up to 3200W of power into low impedance or 70V/100V loads
- In bridged mode, each pair of channels provides up to 6400W into 4Ω, or 70V/100V loads
- Total shared power not to exceed 6400W
- Perfect for R6-MAX, I SERIES Subwoofers and larger IV6 Arrays

Models	Power @ 2Ω	Power @ 4Ω	Power @ 8Ω	Bridged @ 4Ω	Bridged @ 8Ω	70V	100V	Max Output Voltage @ Lo-Z
ALC-404D	4 x 400W	4 x 400W	4 x 400W	2 x 800W	2 x 800W	4 x 400W	4 x 400W	80 Vpk
ALC-1604D	4 x 1600W	4 x 1400W	4 x 1250W	2 x 3200W	2 x 2800W	4 x 1600W	4 x 1600W	142 Vpk
ALC-3202D	2 x 3200W	2 x 2400W	2 x 1250W	1 x 6400W	1 x 4800W	2 x 3200W	2 x 3200W	142 Vpk

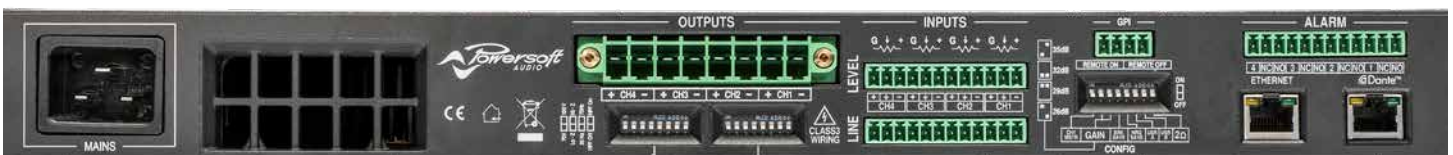

Rear Panel of ALC-404D and ALC-1604D

Visit www.communitypro.com to learn more, or contact the Community TAG Team (Technical Applications Group) for technical and applications assistance at 1+ (610) 876-3400 or tagteam@communitypro.com

Dante® is a registered trademark of Audinate Pty Ltd.

Loudspeaker Specifications

Please refer to the Community website for additional information and full specifications

I SERIES

Point Source 600 Medium Power 12" or 15" Two-Way Loudspeakers

Medium power 600W continuous power handling, 12-inch (305mm) ferrite woofer with 2.5-inch (64mm) voice coil, or 15-inch (381mm) ferrite woofer with 3-inch (76mm) voice coil, and 1.4-inch exit, 3-inch (76mm) voice coil titanium diaphragm ferrite HF driver. Rotatable constant-directivity horns. User selectable passive or biamp operation. Easily configured low profile rigging hardware available for multiple indoor applications (see BalancePoint™ Flyware information).

IP6-1122 12" Two-Way

- **Transducers:** LF 1 x 12", HF 1 x 1.4"
- **Operating Range / Sensitivity*:** 37 Hz - 19 kHz; 94 dB
- **Beamwidth HxV:** 60° x 40°, 60° x 60°, 90° x 40°, 90° x 60°, 90° x 90°, 120° x 60°
- **Power and Impedance:** 600W continuous @ 8 ohms

IP6-1152 15" Two-Way

- **Transducers:** LF 1 x 15", HF 1 x 1.4"
- **Operating Range / Sensitivity*:** 30 Hz - 19.5 kHz; 95 dB
- **Beamwidth HxV:** 60° x 40°, 60° x 60°, 90° x 40°, 90° x 60°, 90° x 90°, 120° x 60°
- **Power and Impedance:** 600W continuous @ 8 ohms

Point Source 800 High Power 15" Three-Way Loudspeakers

High power, 600W (LF) / 275W (MF/HF) continuous power handling, 15-inch (381mm) neodymium woofer, 2-inch exit M200HP ketone polymer MF compression driver, 1.4-inch exit ketone polymer diaphragm neodymium HF driver. Rotatable constant-directivity horns. User selectable biamp or triamp operation. Easily configured low profile rigging hardware available for multiple indoor applications. (See BalancePoint™ Flyware information).

IP8-1153 15" Three-Way

- **Transducers:** LF 1 x 15", MF 1 x 2", HF 1 x 1.4"
- **Operating Range / Sensitivity*:** 33 Hz - 18.5 kHz; LF 96 dB, MF/HF 107 dB
- **Beamwidth HxV:** 60° x 40°, 60° x 60°, 90° x 40°
- **Power and Impedance:** 600W (LF), 275W (MF/HF) continuous @ 8 ohms

Point Source 800 High Power Mid-High Loudspeakers

High power 275W continuous power handling, 2-inch exit M200HP ketone polymer MR compression driver, 1.4-inch exit ketone polymer diaphragm neodymium HF driver. Rotatable constant-directivity horns. User selectable passive or biamp operation. Easily configured low profile rigging hardware available for multiple indoor applications. (See BalancePoint™ Flyware information).

IP8-0002 Mid-High

- **Operating Range/ Sensitivity*:** 355 Hz - 18.5 kHz; MF 107 dB, HF 108 dB
- **Beamwidth HxV:** 60° x 40°, 60° x 60°, 90° x 40°
- **Power and Impedance:** 275W continuous @ 8 ohms

Subwoofers

I SERIES similar-sized rectangular enclosures, construction, finish and aligned suspension points for seamless flown array integration. User selectable single amp or dual amp operation on the dual subwoofer models. Rubber feet included for floor installation. Easily configured low profile rigging hardware available for multiple indoor applications. (See BalancePoint™ Flyware information).

IS600 Family (Medium Power)

- **LF Transducers:** Single or Dual 12", 15", 18" - Ferrite
- **Power and Impedance:** Single LF - 700W @ 8 ohms
Dual LF - 1400W @ 4 ohms

IS800 Family (High Power)

- **LF Transducers:** Single or Dual 12", 15", 18" - Neodymium
- **Power and Impedance:** Single LF - 1000-1600W @ 8 ohms
Dual LF - 2000-3200W @ 4 ohm

Compact 600 Two-Way Point Source Loudspeakers

Designed to provide fill and distributed coverage for smaller spaces, they are styled and voiced similarly to the larger I SERIES models. The 6.5-inch IC6-1062 has 100° x 100° coverage. Both the single 8-inch IC6-1082 and dual 8-inch IC6-2082 have rotatable constant-directivity horns (HxV: 90° x 60° or 120° x 60°). All I SERIES Compacts are available in passive or 70V/100V models. U-Brackets and Vertical Yokes are mounting options.

IC6-1062

- **Operating Range:** 56 Hz - 18.5 kHz
- **Power and Impedance:** 150W continuous @ 8 ohms

IC6-1082

- **Operating Range:** 53 Hz - 19.5 kHz
- **Power and Impedance:** 250W continuous @ 8 ohms

IC6-2082

- **Operating Range:** 49 Hz - 20 kHz
- **Power and Impedance:** 300W continuous @ 16 ohms

*Highest representative output among various horn pattern options per model.
dB SPL sensitivity is measured at 1W/1m
Full specifications for these, and other models, are available at www.communitypro.com.

Loudspeaker data files are available for EASE® and EASE® Focus acoustic modeling software to facilitate optimum system design.
(EASE® and EASE® Focus are products of AFMG Technologies GmbH.)

I SERIES

Modular Vertical Array 600

A scalable, adaptive sound reinforcement system featuring two full-range array elements with complementary, discreet vertical coverage angles (5°/15°) permit the creation of true line array configurations for longer throws, gently curving progressive curvature arrays for medium size applications and compact constant-curvature arrays where nearfield point source coverage is required. Up to 5° of splay between elements eliminates excessive overlap or coverage gaps.

Built-in Passive Acoustic Optimization (PAO) provides up to 19dB of frequency-selective attenuation within each element for unmatched SPL coverage consistency without additional amp or DSP channels. An exclusive PAO module within EASE® Focus 3 software quickly calculates ideal passive array parameters.

A matching, arrayable, high power 18" subwoofer provides deep, impactful low frequency support for any array configuration.

Rigging accessories are available for indoor applications (see Modular Vertical Array Rigging Accessories information on page 16), or contact Community for more information.

IV6-1122 12" Two-Way

- **Transducers:** LF 1 x 12", HF 2 x 1.7" voice coil
- **Operating Range / Sensitivity*:** 40 Hz - 18.5 kHz; 102 dB
- **Beamwidth HxV:** 120° x 5° max, 120° x 15° max
(Vertical coverage is array dependent)
- **Power and Impedance:** 400W @ 16 ohms

IV6-118S Subwoofer

- **LF Transducer:** 1 x 18"
- **Power and Impedance:** 800W @ 8 ohms

V SERIES

Compact V2 Loudspeakers

Compact 11-ply birch enclosure, DYNA-TECH™ driver protection system, rotatable horn, steel yoke bracket included with vertical standoffs allowing 0°/10°/20° tilt, autoformer models available for 70V/100V applications.

- **Transducers:** LF single/dual 6.5" or 8", HF 1 x 1"
- **Operating Range* / Sensitivity:** 60 Hz - 18 kHz; 92-94 dB
- **Beamwidth HxV:** 90° x 70°

Two-Way 12" or 15" Full-Range

- **Transducers:** LF 1 x 12" or 1 x 15", HF 1 x 1"
- **Operating Range / Sensitivity:** 60 Hz - 18 kHz; 98-99 dB
- **Beamwidth HxV:** 60° x 40°, 90° x 60°
- **Power and Impedance:** 200W RMS, 500W PGM, 8 ohms

Three-Way 12" Full-Range

- **Transducers:** LF 1 x 12", MF 1 x 6.5", HF 1 x 1"
- **Operating Range / Sensitivity:** 60 Hz - 18 kHz; 99-100 dB
- **Beamwidth HxV:** 60° x 40°, 90° x 40°
- **Power and Impedance:** 200W RMS, 500W PGM, 8 ohms

Three-Way 15" Full-Range

- **Transducers:** LF 1 x 15", MF 1 x 6.5", HF 1 x 1"
- **Operating Range / Sensitivity:** 55 Hz - 18 kHz; 99-100 dB
- **Beamwidth HxV:** 60° x 40°, 90° x 40°
- **Power and Impedance:** 200W RMS, 500W PGM, 8 ohms

Subwoofers

VLF208LV: Compact Low Profile

- **Transducers:** LF 2 x 8" large volume
- **Operating Range / Sensitivity:** 30 Hz - 1000 Hz
- **Power and Impedance:** 400W continuous, 4 ohms

V2-212S:

- **Transducers:** LF 2 x 12"
- **Operating Range / Sensitivity:** 35 Hz - 200 Hz, 97 dB SPL
- **Power and Impedance:** 300W continuous, 4 ohms

For technical and applications assistance, please contact the Community TAG Team (Technical Applications Group) at (610) 876-3400 or tagteam@communitypro.com.



Community Professional Loudspeakers is a developer and manufacturer of innovative loudspeaker systems for installed sound applications.

Community products elevate the listening experience at the world's foremost indoor and outdoor sports venues, auditoria, theme parks, worship facilities and convention centers.

For applications that demand reliable, long-term performance and consistent, high-quality sound – often in extreme and challenging environments – Community loudspeakers provide the critical listening experience audiences deserve and facility managers demand.

Based in Chester, Pennsylvania, Community is an American original whose innovative products have shaped the professional sound industry since the company was founded in 1968.

Community Professional Loudspeakers

333 East Fifth Street, Chester, PA 19013-4511 USA

Phone: +1 610 876 3400 • Fax: +1 610 874 0190

communitypro.com